

USER MANUAL

MINI-FILTER

ARTURIA®
YOUR EXPERIENCE • YOUR SOUND

Special Thanks

DIRECTION

Frédéric Brun Kevin Molcard

DEVELOPMENT

Samuel Limier	Corentin Comte	Valentin Lepetit	Pierre Pfister
Stefano D'Angelo	Baptiste Le Goff	Germain Marzin	Benjamin Renard
Baptiste Aubry	Pierre-Lin Laneyrie	Mathieu Nocenti	

DESIGN

Sebastien Rochard Shaun Ellwood Morgan Perrier

SOUND DESIGN

Jean-Baptiste Arthus Victor Morello

MANUAL

Gert Braakman Randy Lee Morgan Perrier Florian Marin

© ARTURIA SA - 2018 - All rights reserved.
11 Chemin de la Dhuy
38240 Meylan
FRANCE
www.arturia.com

Information contained in this manual is subject to change without notice and does not represent a commitment on the part of Arturia. The software described in this manual is provided under the terms of a license agreement or non-disclosure agreement. The software license agreement specifies the terms and conditions for its lawful use. No part of this manual may be reproduced or transmitted in any form or by any purpose other than purchaser's personal use, without the express written permission of ARTURIA S.A.

All other products, logos or company names quoted in this manual are trademarks or registered trademarks of their respective owners.

Product version: 1.0

Revision date: 28 February 2018

Thank you for purchasing Mini-Filter!

This manual covers the features and operation of Arturia's **Mini-Filter**, the latest in a long line of incredibly realistic virtual instruments and plugins.

Be sure to register your software as soon as possible! When you purchased Mini-Filter you were sent a serial number and an unlock code by e-mail. These are required during the online registration process.

Special Messages

Specifications Subject to Change:

The information contained in this manual is believed to be correct at the time of printing. However, Arturia reserves the right to change or modify any of the specifications without notice or obligation to update the hardware that has been purchased.

IMPORTANT:

The software, when used in combination with an amplifier, headphones or speakers, may be able to produce sound levels that could cause permanent hearing loss. DO NOT operate for long periods of time at a high level or at a level that is uncomfortable.

If you encounter any hearing loss or ringing in the ears, you should consult an audiologist.

Introduction

Congratulations on your purchase of Arturia's Mini-Filter!

Since the late 1990s, the French company ARTURIA has received acclaim from players and reviewers alike for designing state-of-the-art software emulations of the venerable analog synthesizers from the 1960s to the 1980s. From the Modular V, back in 2004, to Origin, a modular system of a new generation that we introduced in 2010, to the Matrix 12 released in 2015 and the Synclavier V, released in 2016, our passion for synthesizers and sonic purity has given demanding musicians the best software instruments for professional audio production.

The ARTURIA Mini-Filter is the culmination of over a decade of experience in recreating the most iconic tools of the past.

Arturia has a passion for excellence and accuracy. This led us to conduct an extensive analysis of every aspect of Robert Moog's filter and its electrical circuits, even modeling the changes in behavior over the course of time.

Mini-Filter runs as a plug-in in all major formats inside your DAW. It has easy MIDI learn functionality for hands-on control of most parameters, and as a plug-in also allows parameter automation for greater creative control.

The Arturia team

Table Of Contents

1. Welcome.....	3
1.1. Arturia's Version of Robert Moog's Filter.....	3
1.2. Arturia's secret ingredient: TAE®.....	4
2. Activation & First Start.....	6
2.1. Activate the Mini-Filter license.....	6
2.1.1. The Arturia Software Center (ASC).....	6
2.1.2. Mini-Filter as a plug-in.....	7
2.2. QuickStart: A basic patch.....	8
3. User Interface.....	10
3.1. The Panel.....	10
3.2. The Toolbar.....	11
3.2.1. Save Preset.....	11
3.2.2. Save Preset As.....	11
3.2.3. Import Preset.....	12
3.2.4. Export Menu.....	12
3.2.5. Resize Window options.....	12
3.2.6. Preset browser overview.....	13
3.3. MIDI Learn assignment.....	14
3.3.1. Assigning / un-assigning controls.....	14
3.3.2. Min / Max value sliders.....	15
3.3.3. Relative control option.....	15
3.4. MIDI controller configuration.....	16
3.5. The lower toolbar.....	17
3.5.1. Bypass.....	17
3.5.2. Limit Resonance.....	17
3.5.3. CPU meter.....	17
3.6. The Preset browser.....	18
3.6.1. Searching presets.....	18
3.6.2. Using tags as a filter.....	19
3.6.3. Search Results window.....	19
3.6.4. The Preset Info section.....	19
3.6.5. Preset selection: other methods.....	20
3.6.5.1. Selecting a Preset by type.....	20
3.7. Playlists.....	21
3.7.1. Add a playlist.....	21
3.7.2. Add a preset.....	21
3.7.3. Re-order the presets.....	21
3.7.4. Remove a preset.....	22
3.7.5. Delete a playlist.....	22
4. Mini-Filter overview.....	23
4.1. Sound in close-up.....	23
4.2. Modifying sound.....	24
4.3. Animating sound.....	25
4.4. Mini-Filter Panel sections.....	26
5. Low-Frequency Oscillator.....	27
5.1. Sync.....	28
5.2. Waveform Rate and Phase.....	29
5.3. Rate.....	29
5.4. Phase.....	30
5.5. LFO Modulation Options.....	30
5.5.1. Cut-off Modulation.....	30
5.5.2. Emphasis Modulation.....	30
5.5.3. Seq-Cut-off Modulation.....	30
6. Low Pass Filter.....	31
6.1. Drive.....	32
6.2. Cut-off frequency.....	32
6.3. Emphasis or Q.....	33
6.4. Dry/wet.....	34
6.5. Output Volume.....	34
7. Envelope Follower.....	35

7.1. Sensitivity	36
7.2. Attack and Decay Time.....	37
7.3. Cutoff, Emphasis and LFO rate Mod.....	37
8. Step Sequencer	38
8.1. The Step Controls.....	38
8.1.1. Sequencer Sync.....	39
8.2. Steps	40
8.2.1. Rate and Smooth dials	40
8.3. Smooth	40
8.4. The Modulation Controls	41
8.5. Cut-off Mod.....	41
8.6. Emphasis Mod	41
8.7. LFO Rate Mod	41
9. Software License Agreement.....	42

1. WELCOME

Inventions are usually the result of hard work. But some are happy accidents.

Robert Moog's filter is a bit of both, it's brilliant in its simplicity, but contains a design flaw that is partly responsible for its musical qualities. The design causes a particular kind of distortion that gives the filter a unique sound, loved by artists all over the world. The Arturia Mini-Filter recreates this iconic filter including its "flaws".

The beauty of musical devices created in the sixties and seventies is that they are one-knob one-function devices. So is this filter. It does not stand in the way of creativity the way many computer-based devices can, that often interrupt your creative flow because at a critical moment you cannot remember in which sub/sub menu a certain function hides. We, at Arturia, wish you many happy and inspiring moments when using this device.

1.1. Arturia's Version of Robert Moog's Filter

Mini-Filter closely mimics the original. It has all the features that make the filter such a unique tool for music creation. The main filter unit is surrounded by modules that enable you to animate and control the filter cutoff frequency and its emphasis: an LFO, a Sequencer and an Envelope Follower.

Some highlights:

- Syncable multi-waveform LFO with phase, cutoff and emphasis modulation control.
- Complex EnvelopeFollower with sensitivity control and modulation routing options (filter cutoff-, emphasis- and LFO rate modulation)
- Syncable advanced step sequencer with smooth control and modulation routing options (filter cutoff-, emphasis- and LFO rate modulation)

1.2. Arturia's secret ingredient: TAE®

TAE® (True Analog Emulation) is Arturia's outstanding technology dedicated to the digital reproduction of analog circuits used in vintage synthesizers.

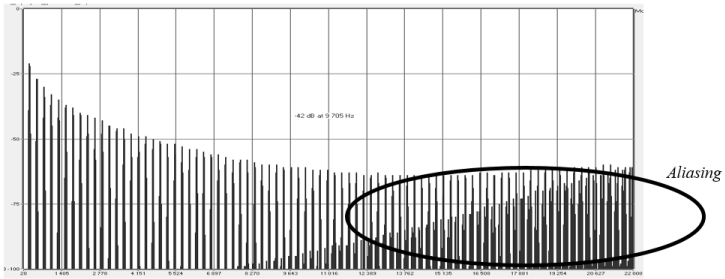

Linear frequency spectrum of a current well-known software synthesizer

TAE®'s software algorithms result in spot-on emulation of analog hardware. This is why Mini-Filter offers an unparalleled quality of sound, as do all of Arturia's virtual synthesizers.

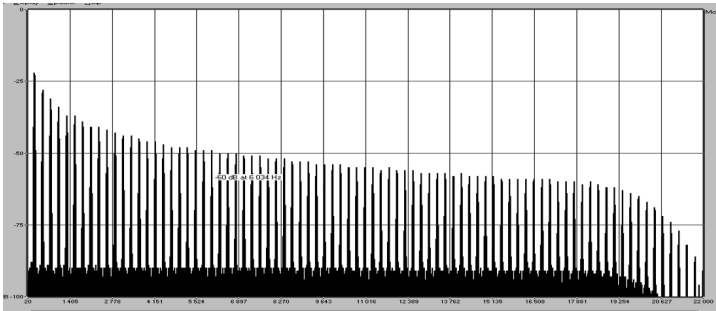

Linear frequency spectrum of an oscillator modeled with TAE®

TAE® combines major advances in the domain of synthesis:

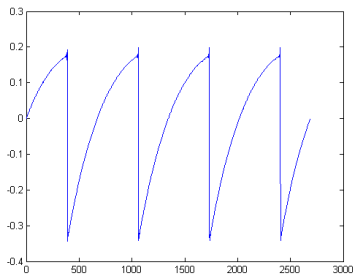

Temporal representation of the "sawtooth" waveform of a hardware synthesizer

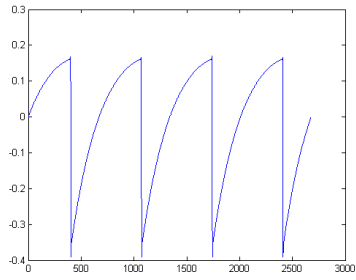

Temporal representation of a "sawtooth" waveform reproduced by TAE®

2. ACTIVATION & FIRST START

Mini-Filter works on computers equipped with Windows 7 or later and macOS 10.10 or later. You can use Mini-Filter as an Audio Unit, AAX, VST2 or VST3 instrument.



Mini-Filter as a VST

2.1. Activate the Mini-Filter license

Once Mini-Filter has been installed, the next step is to activate your license for the software.

This is a simple process that involves a different software program: the Arturia Software Center.

2.1.1. The Arturia Software Center (ASC)

If you have not already installed the ASC, go to this web page:

[Arturia Updates & Manuals](#)

Look for the Arturia Software Center at the top of the page, and then download the version of the installer that you need for your system (macOS or Windows).

Follow the installation instructions and then:

- Launch the Arturia Software Center (ASC)
- Log into your Arturia account
- Scroll down to the My Products section of the ASC
- Click the Activate button

That's all there is to it!

2.1.2. Mini-Filter as a plug-in

Mini-Filter comes in VST, AU and AAX plug-in formats for use in all major DAW software such as Ableton, Cubase, Logic, Pro Tools and so on. As a plugin it will:

- synchronize to your DAW's host tempo/bpm rate when tempo is a factor
- allow you to automate numerous parameters using your DAW's automation system
- allow you to use several instances of Mini-Filter simultaneously

2.2. QuickStart: A basic patch

The patch below is an ideal starting point for getting to know the Mini-Filter plugin. We will use the sequencer to modulate the filter frequency cut-off. It illustrates how you can use Mini-Filter to highlight beats in a measure using Sequencer Cutoff modulation. In the example below, we'll use Ableton, but it will work in a similar way in other DAWs.

Please load the default factory preset. This ensures that you have all knobs in the correct starting position.

Let's give it try:

- load an instance of Mini-Filter in a track of your DAW
- load a four-beat clip into an audio track
- make the interface of the Mini-Filter visible by clicking on the tool icon

Now start your DAW and the loop will sound in all its glory. By default the Sequencer sync switch is active and the filter cutoff frequency is set to almost maximum. That's ok with our demonstration.

By limiting the number of steps in the sequence to two we can create an on/off effect:

- set the number of sequencer steps to 2. (Keep an eye on the tooltip in the lower left of the tool bar.)
- set the Cutoff Mod Dial to +10 and observe what happens on the main Cutoff frequency dial; an orange indicator will magically appear and illustrate the effect of what you do with the SEQ Cutoff MOD dial.
- set sequencer step two knob fully counterclockwise.

If all is well you'll now hear the sound disappear every other step. What happens? By setting the Cutoff Mod Dial to +10 and the step modulation intensity of the first step to -1 the sequencer closes the filter on the step.

Now increase the number of steps to four and try muting other steps.



Muting beats in a bar

There is a lot more to this simple example by including the rate and smooth dials in the experiment. We'll start from the same situation as in the previous example:

- set the number of sequencer steps to 2.
- if it is not already; set the Cutoff Mod Dial to +10
- set sequencer step two knob fully counterclockwise

The Rate setting is linked to the sync switch. The Sequencer Sync Rate is set to 1/4 in this position: one sequencer step equals 1/4th of a four beat measure; the sequencer will advance one step with every beat. If you double the rate to 1/8 the sequencer will run twice as fast as the DAW clock. Intermediate rate and smooth values will generate all sorts of interesting rhythmic effects.

- now set the Rate to 1/1; the Sequencer will now advance one step every four beats. In other words it will mute every other measure.

By setting the Smooth knob to about 0.047 (the tooltip value) the transition will be less abrupt; the sound fades in and out.

3. USER INTERFACE

Mini-Filter is packed with great features and in this chapter, we'll take a tour and show you what it can do. We think you'll be amazed by the range of filtering options this plugin is capable of.

Mini-Filter is very flexible. That will always be the main focus of every Arturia product: to unleash your creativity while remaining easy to use.

3.1. The Panel

We will have a detailed look at the [Panel \[p.23\]](#) in another chapter.

3.2. The Toolbar

The toolbar that runs along the top edge of the instrument provides access to many useful features. The first seven of these features can be accessed by clicking on the Mini-Filter section at the very top left-hand corner of the instrument window.

We'll go through each of these functions in the following sections.

3.2.1. Save Preset

This option will overwrite the active preset with any changes you have made, so if you want to keep the source preset also, use the Save As option instead. See the next section for information about this.

3.2.2. Save Preset As...

If you select this option you are presented with a window where you can enter information about the preset. In addition to naming it, you can enter the Author name, select a Bank and Type, select tags that describe the sound, and even create your own Bank, Type, and Characteristics. This information can be read by the preset browser and is useful for searching the preset banks later.

You can also enter freeform text comments in the Comments field, which is handy for providing a more detailed description.

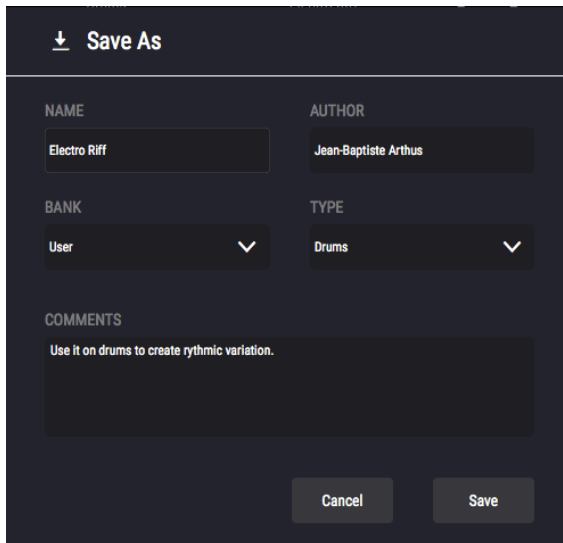

↓ Save As

NAME	AUTHOR
Electro Riff	Jean-Baptiste Arthus
BANK	TYPE
User	Drums
COMMENTS	
Use it on drums to create rhythmic variation.	
Cancel	Save

Save as Preset

3.2.3. Import Preset

This command lets you import a preset file, which can be either a single preset or an entire bank of presets. Both types are stored in .mfix format.

After selecting this option the default path to these files will appear in the window, but you can navigate to whichever folder you are using to store presets.

3.2.4. Export Menu

You can export presets in a number of ways; as a single preset and a bank or as a playlist.

- **Export Single Preset:** Exporting a single preset is handy when you want to share a preset with someone else. The default path to these files will appear in the "save" window, but you can create a folder at another location if you like. The saved preset can be reloaded with the import preset menu option.
- **Export Bank:** This option can be used to export an entire bank of sounds from the instrument, which is useful for backing up or sharing presets.
- **Export All Playlists:** This is an option you could use to prepare for a performance. It also allows you to transfer your playlists to another computer.

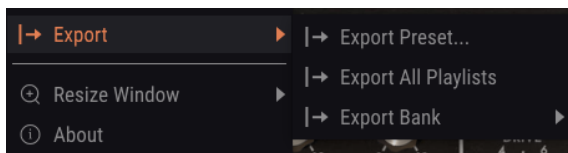

Export a bank of presets

3.2.5. Resize Window options

The Mini-Filter window can be resized from 60% to 200% of its original size without any visual artifacts. On a smaller screen such as a laptop, you might want to reduce the interface size so it doesn't dominate the display. On a larger screen or a second monitor, you can increase the size to get a better view of the controls. The controls work the same at any zoom level but the smaller ones can be harder to see at the smaller magnification values.

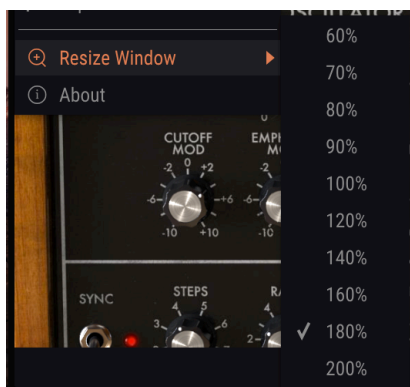

The Resize Window menu

3.2.6. Preset browser overview

The [Preset browser \[p.18\]](#) can be opened by clicking the library symbol on the toolbar. The filter, name field and left / right arrows in the toolbar all assist with preset selection.

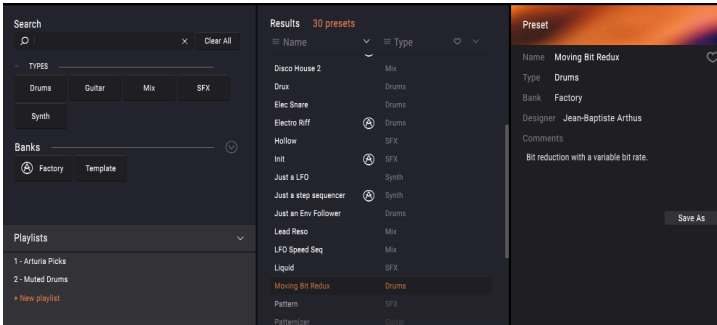

The Preset Browser

3.3. MIDI Learn assignment

The MIDI plug icon at the far right side of the toolbar places the instrument in MIDI learn mode. MIDI-assignable parameters will be shown in purple, which means you can map physical controls to those destinations inside the instrument. A typical example might be to map a real expression pedal to the Output Volume control, or buttons on a controller to the Preset selection arrows so you can change the preset from your hardware keyboard.

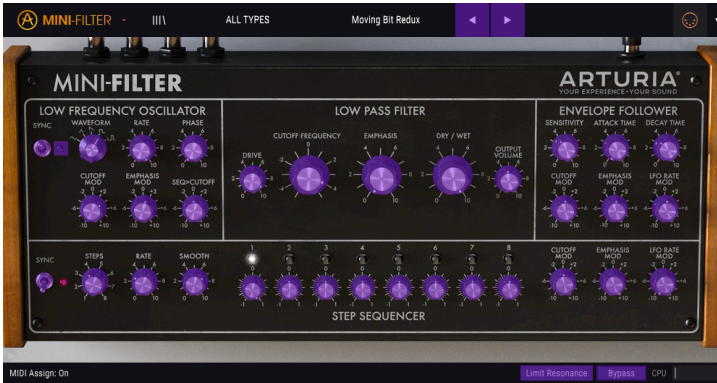

MIDI Learn mode - top section

In the image above one of the parameter dials is red. That means it has already been assigned to an external MIDI control. It can be reassigned, though.

 Remember that you can also assign the Preset Forward and Backward arrows to an external control.

3.3.1. Assigning / un-assigning controls

If you click on a purple area you'll put that control into learning mode. Move a physical dial, fader, or button and the target goes red, indicating that a link has been made between the hardware control and the software parameter. There's a popup window that displays which two things are being linked and an un-assign button that will disconnect the two.

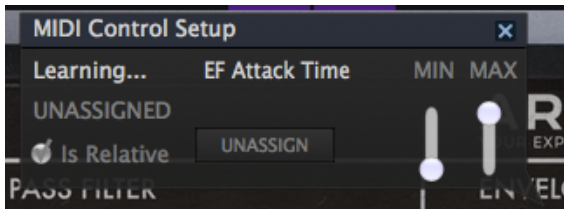

Midi Control Setup

3.3.2. Min / Max value sliders

There are also minimum and maximum value sliders that you can use to restrict the parameter change range to something other than 0%-100%. For example, you might want the Master Gain to be controllable via hardware from 30% to 90%. If you made this setting (Min set to 0.30 and Max set to 0.90) your physical dial would be unable to alter the volume lower than 30% or higher than 90%, no matter how far you turned it. This is very useful for making sure you can't accidentally make the sound too quiet or too loud when performing.

In the case of switches which only have two positions (on or off), those would normally be assigned to buttons on your controller. But it is possible to toggle those with a fader or other control if you like.

3.3.3. Relative control option

The final option in this window is a button labelled "Is Relative". It is optimized for use with a specific type of control: one which sends only a few values to indicate the direction and speed at which a dial is turning, as opposed to sending a full range of values in a linear fashion (0-127, for example).

To be specific, a "relative" dial will send values 61-63 when turned in a negative direction and values 65-67 when turned in a positive direction. The turn speed determines the parameter response. Refer to the documentation of your hardware controller to see if it has this capability. If so, be sure to switch this parameter on when setting up its MIDI assignments.

When configured this way, movements of the physical control (usually a dial) will change the software parameter by starting at its current setting, rather than being an "absolute" control and snapping it to some other value as soon as you start to move it.

This can be a great feature when controlling things like volume, filter, or effect controls since you won't usually want them to jump noticeably from their current setting when they are modified.



Pitch Bend, Mod Wheel and Aftertouch are reserved MIDI controllers that cannot be assigned to other controls.

3.4. MIDI controller configuration

There's a small arrow at the far right-hand side of the toolbar that deals with MIDI controller configurations. This allows you to manage the different sets of MIDI maps you may have set up for controlling the instrument's parameters from MIDI hardware. You can copy the current MIDI assignment setup or delete it, import a configuration file or export the currently active one.

This is a quick way to set up different hardware MIDI keyboards or controllers with Mini-Filter without having to build all the assignments from scratch each time you swap hardware.

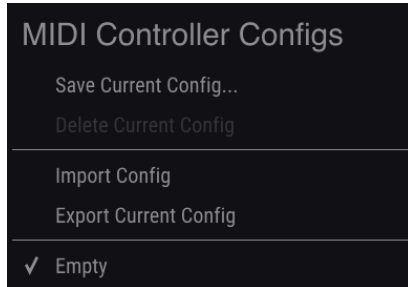

MIDI controller configuration

Note the check mark next to one of the controller names: that indicates that the default configuration is currently active.

3.5. The lower toolbar

At the left-hand side of the lower toolbar, you will see a readout showing the value or state of whatever control you are modifying. It will also display the current value of a parameter without editing it: just hover the cursor over the related control and the value will appear.

At the right-hand side of the lower toolbar are several small windows and buttons. These are very important features, so let's take a closer look at them.



The lower toolbar

3.5.1. Bypass

Activating the bypass option will disable Mini-Filter.

3.5.2. Limit Resonance

The Filter of the Mini-Filter is capable of self-oscillation. When you set Emphasis to maximum the filter will become an oscillator. By default, self-oscillation is off. This option allows you to turn it on.

3.5.3. CPU meter

The CPU meter is used to monitor how much of your computer's CPU is being used by the instrument. If you stress your computer too much, the performance of your computer may suffer.

3.6. The Preset browser

The preset browser enables you to search, load and manage sounds in Mini-Filter. It has a couple of different views but they all access the same banks of presets. You access the preset browser by clicking on the library symbol next to the Arturia logo.

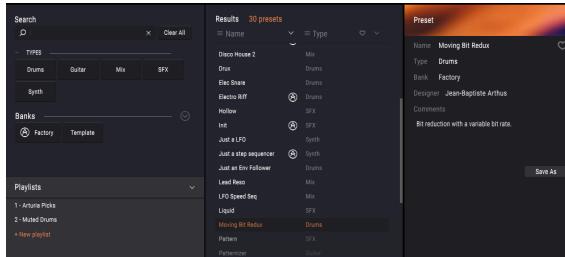

The Preset Browser button

The Type category window in which the characteristics of a preset are listed may be collapsed and expanded using the symbol preceding it.

3.6.1. Searching presets

The Search screen has a number of sections. By clicking on the Search field at the top left you can quickly enter any search term to filter the preset list by patch name. The Results column is updated to show the results of your search. Press the Clear Filters button in the search field to clear the search.

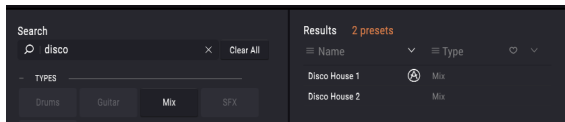

Using the filter to search for presets

3.6.2. Using tags as a filter

You can also search using different tags. So for example by clicking on the drums tag in the Types field you can show only presets that match that tag. The tag fields can be shown or hidden by using the small down arrow buttons in their title fields. Results columns can be sorted by clicking the same arrow button in their own section.

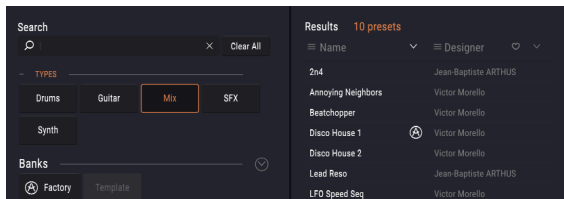

Using tags to search for presets

You can select multiple fields to perform narrower searches. So by entering a text search and also specifying Type, Bank and Characteristics options you could see only the presets that match those exact criteria. Deselect any tag in any area to remove that criterion and widen the search without having to go back and start again.

The second Results column can be switched to show Type, Sound Designer, Favorite or Bank tags depending on how you like to search. Click on its options menu button just next to its sort arrow.

3.6.3. Search Results window

Once you have a list of found presets in the search column, you can click the sort arrow to reverse the alphabetical order.

Click the options menu button in the second Results column to order its display results by Type, Sound Designer, or Bank tags. Click the sort arrow to reverse the alphabetical order.

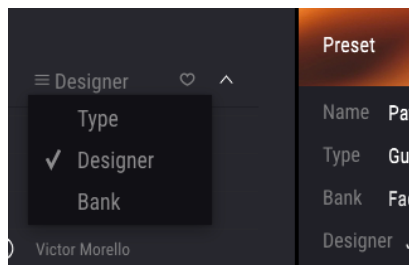

Selecting results by type

3.6.4. The Preset Info section

The Info column on the right side of the search field shows you information about any preset. The information for User Presets may be changed here: Name, Type, Bank, etc.

However, if you want to alter the information for a Factory preset you must first use the "Save As" command to re-save it as a User Preset. You can now change the preset info in the "save as" dialogue window.

3.6.5. Preset selection: other methods

The pull-down menu to the right of the Search menu provides a different way to select presets. The first option in this menu is called "Filter", and it will display the presets that fit the search terms you used in the search field. So if you searched for the word "Ambient" in the main search area, the results of that search will appear here.

3.6.5.1. Selecting a Preset by type

Similarly, if you previously selected Type: Synth in the Search field you would see the results of that search in this area instead.

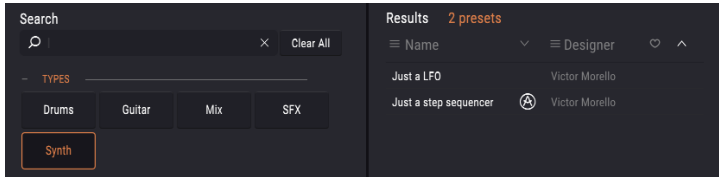

Selecting a preset by type

Selecting the "All Types" option in the pull-down menu will bypass the search criteria and show the entire list of presets.

Clicking on the name field in the centre of the toolbar will show you a list of all available presets. The list will also take into account any selections you have made in the search field. So if you have preselected a Characteristic such as "Chaos", this shortcut menu will only show you presets that match that tag.

The left and right arrows in the toolbar cycle up and down through the preset list: either the full list or the filtered list that resulted from the use of one or more search terms.

The Info column on the right side of the search field shows specific information about each preset. The information for User presets may be changed here: Name, Type, Favorite, etc.

3.7. Playlists

In the lower left corner of the Preset Browser window is a feature titled Playlists. This is used to collect presets into different groups for different purposes, such as a set list for a particular performance or a batch of presets related to a particular studio project.

3.7.1. Add a playlist

To create a playlist, click the plus sign at the bottom. Give the playlist a name and it will appear in the Playlists menu. You can rename the playlist at any time; just click the pencil icon at the end of its row.

3.7.2. Add a preset

You can use all of the options in the Search window to locate the presets you want to have on your playlist. Once you have found the right preset, click and drag it onto the playlist name.

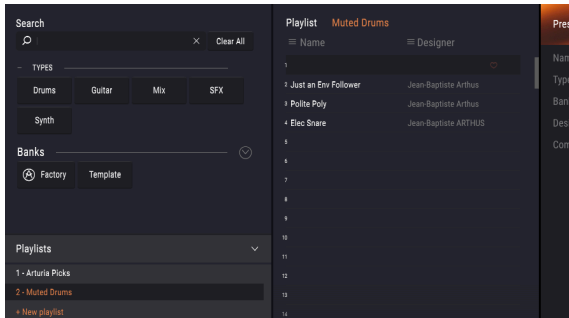

playlist example

To view the contents of a playlist, click on the playlist name.

3.7.3. Re-order the presets

Presets may be reorganized within a playlist. For example, to move a preset from slot 1 to slot 3, drag and drop the preset to the desired location.

This will cause the other presets to be bumped up in the list to accommodate the new location of the preset being moved.

3.7.4. Remove a preset

To delete a preset from a playlist, select the preset and click the "x" at the end of the preset row.

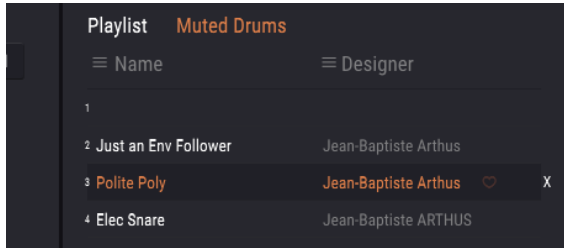

Click "X" to remove a preset from a playlist

3.7.5. Delete a playlist

To delete an entire playlist, click the x at the end of the playlist row. This will only delete the playlist, it will not delete any of the presets inside the playlist.

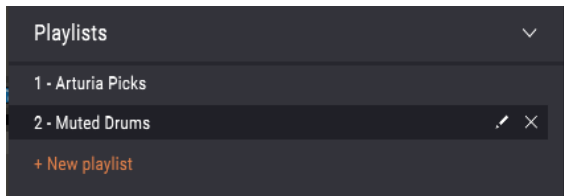

Deleting a playlist

4. MINI-FILTER OVERVIEW

Believe it or not but the synthesizer filter as we know it has its origins in the research of a phone company. Bell and AT&T needed to transmit several phone calls over a single line. They developed a filter that was able to split the frequency spectrum into layers using filters. They probably never imagined that their filter would have musical applications.

4.1. Sound in close-up

A filter enables you to have a look at sound, at any sound in detail. A filter can emphasize or suppress the harmonics contained in a sound. In doing so it changes its timbre. Traditionally filters are used in combination with oscillators. The Mini-Filter plugin is a more general tool that will filter anything you feed it (as long as it is sound). It's like a magnifying glass that reveals everything that is present in the sound. Or to use a better analogy; it is a searchlight that moves over any sound source dynamically revealing its harmonic content. It can sweep over a sound with a broad beam or with a very focused narrow beam, this is referred to as Q or emphasis.

Any sound consists of sine wave frequencies, each with a different loudness. These frequencies are usually not random but appear as "families", they have a common ground; a fundamental frequency. A vibrating fundamental frequency creates related frequencies called harmonics. Some of these frequencies are even, some are odd. The mix of odd and even frequencies and their amplitude (loudness) will depend on the environment in which they arise. In the course of history, many shapes and materials have been invented to resonate in specific ways. In our language, we have many words that describe a specific behavior of harmonic families. We use words like banging, bubbling, roaring, thumping, reverberating, rattling, whizzing and wagging. Some are pleasing to the ear and others are not.

The harmonics largely determine the characteristic of the sound. Whenever an object gets hit, harmonic families of related frequencies will arise, some harmonic family members will become prominent and stay alive for a long time, they will resonate and create new family members. Others will die out quickly because the shape or the material through which they have to move does not sustain them.

A filter is basically a circuit that allows frequencies to resonate in specific ways. It will favor certain frequencies and be hostile to others. Unlike a fixed material form (a violin body) it can be made to resonate in different ways.

4.2. Modifying sound

The Filter used in Mini-Filter is a lowpass filter. It's a name that accurately describes what it does; it attenuates (weakens) or removes frequencies above its cut-off frequency.

An open filter, with the cut-off frequency set to maximum, will allow all frequencies to pass through. When you lower the cut-off frequency the high frequencies will start to disappear; frequencies that lie above the cut-off frequency will be attenuated. Lower it further and the midrange will disappear. Close it completely and only silence remains.

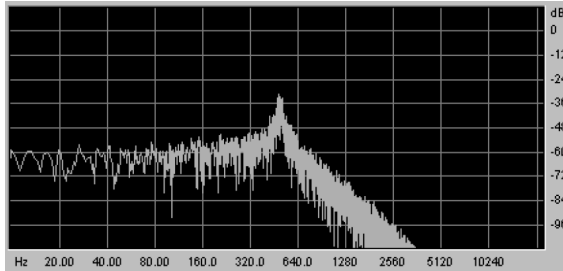

Noise filtered through a low pass filter

The cut-off frequency is the point where the actual filtering takes place. Early users of filters discovered that they could alter the sonic properties of a filter by feeding the output of the filter back into itself. Creating such a feedback loop results in a resonance peak around the cut-off frequency. In the Mini-Filter plugin, this type of resonance is called emphasis. The amount of emphasis can be controlled manually, by the LFO, the Sequencer and the Envelope Follower.

Filters differ in how they remove frequencies above the cut-off point. It is possible to design a filter that will cut-off the frequencies above the cut-off frequency in a very drastic way; if the cut-off point is at 500 Hz it would make a frequency of 501 Hz inaudible. The result of such filtering is very unmusical. Instead, filters are designed to dampen frequencies gradually.

In the above example, it would mean that the 501 Hz frequency is still audible but somewhat reduced in amplitude. A frequency of 550 Hz will probably also be audible but will be even more reduced in amplitude. This is referred to as the roll-off of a filter. Some filters have a steep roll-off, others a more gradual roll-off. The steepness of filter's roll-off is determined by the number of its poles, 4 pole filters have roll-off that is much steeper than 2 pole filters. The Mini-Filter is 4 pole filter with a roll-off of 24 dB per octave.

4.3. Animating sound

A filter modifies sound by removing frequencies above the cut-off point. Doing this manually is not very effective, although it allows getting a grasp of what is happening. What turns the filter into an interesting musical tool is changing the cut-off point and its resonance dynamically. The Mini-Filter achieves this by using an LFO, a Sequencer or an Envelope Follower to control cut-off frequency and resonance of the filter. Please refer to the [LFO \[p.27\]](#), [Sequencer \[p.38\]](#) and [Envelope Follower \[p.35\]](#) chapters for more details.

Robert Moog's filter design soon caught on, because of its musical qualities. Strangely enough what made his design sound musical is now considered to be a design flaw; it added a small amount of distortion to the filtered sound.

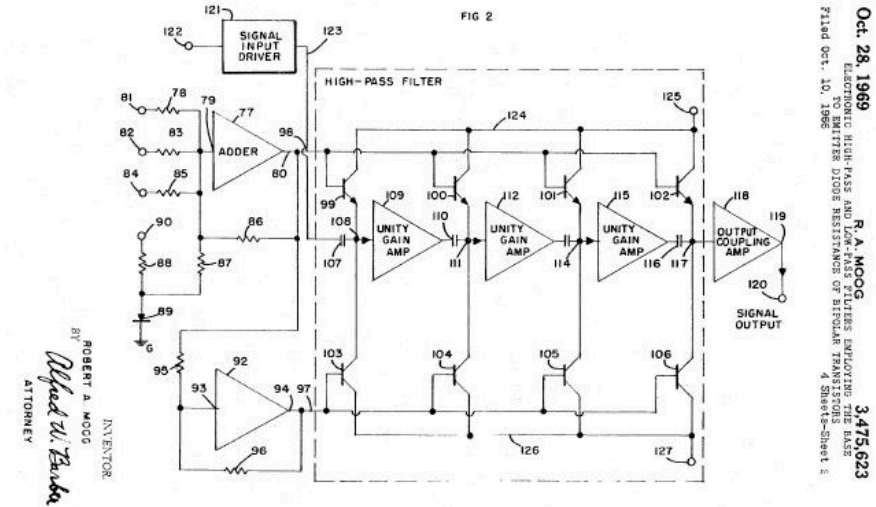

Robert Moog's Ladder Filter Schematic, as submitted to the US Patent Office

In technical terms, his filter is referred to as a 4 pole 24 dB ladder filter. If you look at the design schematic above it's easy to see why it's called a ladder filter. If you look carefully you can also see the four poles. Each of these poles adds 6 dB to the final filter slope. Four-time six as a rule adds up to 24. Hence, the total amount of filtering will add up to 24 Db per octave.

4.4. Mini-Filter Panel sections

The Mini-Filter Panel consists of four sections:

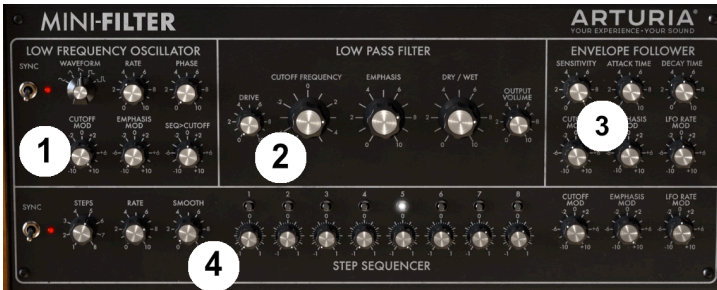

Mini-Filter Sections

1. The Low Frequency Oscillator [LFO \[p.27\]](#)
2. The [Low Pass Filter \[p.31\]](#) (LPF)
3. The [Envelope Follower \[p.35\]](#)
4. The [Step Sequencer \[p.38\]](#)

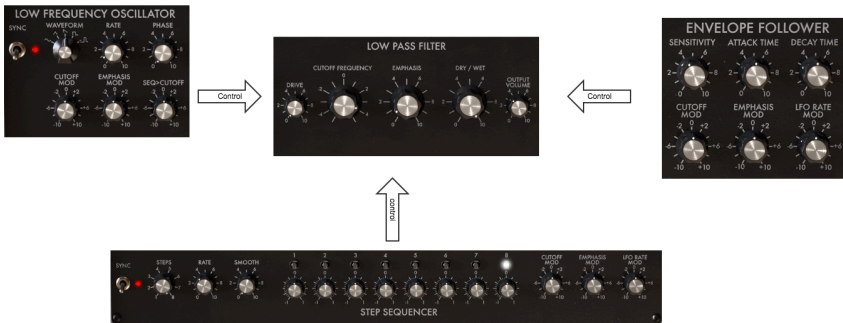

Signal flow

The Low Pass Filter is the workhorse of the unit. It receives control signals from the [Low Frequency Oscillator \[p.27\]](#), the [Sequencer \[p.38\]](#) and the [Envelope Follower \[p.35\]](#)

Before we continue a word about the dials of the Mini-Filter: Not all knobs are the same, some are uni-polar, some bi-polar. All in all, there are no less than four different types of dials.

Uni-polar dials work only in the positive domain, they are scaled from "0" to "10". Bi-polar dials centre in the middle; turn them to the left and they create negative forms of modulation. Turn to the right and they modulate in the positive domain. Both positive and negative are scaled from "0" to "10".



Double click on a knob to reset the knob to its default position.

5. LOW-FREQUENCY OSCILLATOR

An LFO is low-frequency oscillator that can produce various waveforms at sub-audio level. These waveforms can then be used to modulate

- the cut-off frequency of the Low Pass Filter
- the emphasis of the Low Pass Filter
- the cut-off modulation amount applied by the Sequencer

A well-known application of LFO modulation is the filter sweep; the LFO waveform is used to animate the cut-off point of the Low Pass Filter.



The LFO

If you want to try this with the Mini-Filter:

- copy an instance of the Mini-Filter to an audio track on your DAW and load a clip that you want to filter
- press start on your DAW, you should now hear the clip playing
- switch LFO sync in the LFO section of Mini-Filter to off
- set rate to about 1
- set the cut-off of the Low Pass Filter to about -2.
- set emphasis to about 7, you should now hear the ringing of the filter. By increasing the emphasis amount you have narrowed the filter band to such an extent that filter almost starts to self-oscillate.
- Now set the cut-off modulation in the LFO section to +3

You should now hear the filter sweep. It dynamically selects a narrow harmonic band from the source in your clip. If you want to experiment further select a triangle or sine waveform.

If you're into rhythmic effects select the rightmost waveform and slowly turn up drive.

Below is an overview of the modulation routings of the Mini-Filter.

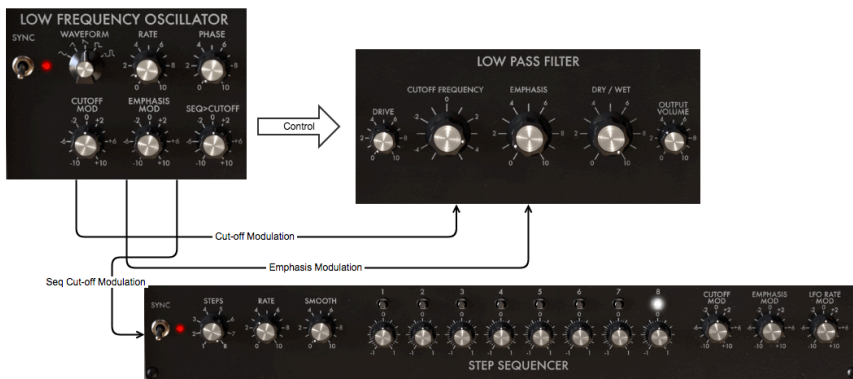

Signal flow: LFO in closeup

Many modulation controls are Bi-polar, which means that they can control their target in the positive range and in the negative range.

5.1. Sync



The sync dial

The sync control switch determines whether the LFO will run freely or synchronize to the master clock of your DAW.

Of all the skills you can master in music, mastering sync is one of the important. Sync is what happens when two or more units (effects, oscillators, filters, voices) synchronize their rhythms to each other.

Sync is also how we humans link to the flow of music. If you want to capture the attention of your listeners you have to understand how to make captivating sync patterns. Mini-Filter can sync to your DAW in different ways, its Rate dial allows you to sync proportionally; at double speed, at half-speeds or somewhere in between.

The Mini-Filter has two tools that can be synced: the LFO and the Sequencer. In synced mode, you can use them to create accents or rhythmic shifts.

Sync is essential when you want to create interesting musical patterns in polymeter or polyrhythm. Polymeter is a technique where you mix two rhythms with a different number of beats. If for instance, you mix a 5/4 and 4/4 rhythms they will go in and out of sync, creating unexpected accents. The Mini-Filter can highlight certain steps by opening the filter, adding additional interest to an already complex shifting pattern.

Another area where sync is important is when using syncopated rhythms. In a syncopated rhythm, the accent falls on the offbeat step in a bar. If you mix on- and offbeat accents in such a way that weak and strong dynamics alternate and shift, you have a recipe for keeping listeners spellbound.

Again here the Mini-Filter comes to the rescue. By copying several instances of the Mini-Filter to a number of tracks you can create very interesting dynamic patterns. Then use the Mini-Filter Sequencers in synced mode and create different accents in each instance of Mini-Filter by modulating the Filter cutoff frequency. By combining different sync rates all sorts of dynamic patterns are possible: the dynamic variation in timbres created in this way on the on- or off-beat steps creates a groove that is difficult to achieve by other means. Sync is a vastly underrated musical tool.

5.2. Waveform Rate and Phase



Waveform, Rate and Phase

The Waveform selector allows you to choose from five different waveforms: sine, triangle, sawtooth, square, and sample & hold. The Saw wave is a descending saw wave. The variable pulse wave has a 25% duty cycle, which is tech-talk for saying that it is on (high) for 25% of the time.

The Rate dial sets the speed of the LFO frequency (0.1Hz up to 2000Hz) and the phase dial sets the starting point of the LFO wave.



Waveform options

5.3. Rate

By default, the LFO will be synced to the clock of your DAW and will follow any changes in your DAW's clock proportionally. In the default setting, LFO will sync to the clock of your DAW in a one-to-one relationship. Turning up the rate dial will change that relationship proportionally: the LFO rate will be quantized and cycle through a number of ratios: 1:0.5, 1:1, 1:2, 1:4, 1:8, etc.



Tip: Mini-Filter displays the sync ratio in the Tooltip area on the Toolbar.

If needed you can uncouple the LFO from the DAW's tempo by disabling sync. The LFO rate will now be independent of the DAW clock.

In synced mode, the LFO ranges from 4/1 to 1/128 beats (default: 1/1). In unsynced mode, it ranges from 0.1Hz to 2000Hz (default: 1Hz).

5.4. Phase

The Phase dial adjusts the starting point of the LFO's wave cycle. Note that the LFO is always running even when the DAW is stopped.

5.5. LFO Modulation Options

The first two of the LFO modulators control the Filter cut-off and Emphasis.



Modulation options

5.5.1. Cut-off Modulation

Varying the cut-off point, the point where the filter starts removing frequencies from the sound spectrum, changes the timbre of the sound. More about this in the [Filter chapter \[p.31\]](#). This dial controls the amount with which the LFO will modulate the Filter cut-off frequency. Notice that when you move the dial, an orange circle will appear on the Filter cut-off frequency dial that gives you valuable feedback about the amount of control being applied. This kind of feedback is typical for the Mini-Filter and will appear everytime you apply a modulation source to a target.

5.5.2. Emphasis Modulation

Here you set the width of the band with which the filter attenuates the incoming signal. By increasing the emphasis amount you will focus the filter and force it to pass only frequencies in the vicinity of the frequency cut-off point.

5.5.3. Seq>Cut-off Modulation

The sequencer is another useful tool to modulate the filter cut-off point. With the step dials, you set the amount of modulation that each individual step will apply. This dial modulates the values you've programmed in these steps. In other words, it modulates the modulation values of the sequencer steps.

6. LOW PASS FILTER

A filter removes frequencies from a sound source. It is the primary component in subtractive synthesis. It is widely used in every contemporary music style. It's not an overstatement to say that nearly every track you hear in the media has been filtered in some way or another. Frequencies were removed or boosted, instruments suppressed in a mix, frequency ranges made more prevalent to capture your attention. What gives the Low Pass Filter its unique qualities is that it focuses on the harmonics around a cut-off point. Modulating the cut-off frequency of a filter varies the timbre of sound over time. It can be considered to be a sophisticated equalizer that selectively reduces the high frequencies of a sound.

i Note: Mini-Filter can be made to self-oscillate and thus act as an oscillator. As the Mini-Filter is an audio filter it is designed not to go into self-oscillation. Click on the "Limit Resonance" option in the lower Toolbar to toggle self-oscillation on and off. In Limit Resonance mode oscillation is limited to 0.74, just before self-oscillation.

The Mini-Filter can receive control signals that modify the filtering process from the other sections of the Mini-Filter:

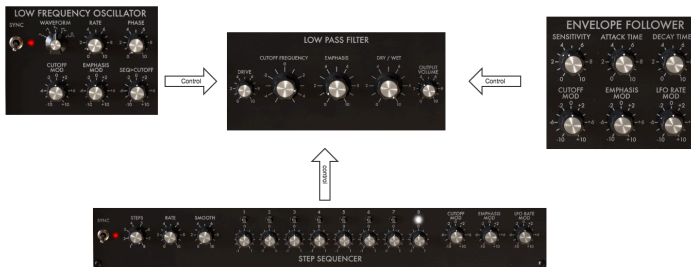

Mini-Filter signal flow

The Mini-Filter mimics the flaws original design, its resonance is not constant. In low-frequency ranges, the resonance disappears. So when you filter a sound with a lot of bass content, the low frequencies will have that specific juicy full-bodied presence that made the ladder filter famous.

Another unique feature of the Mini-Filter is that it's a stereo Filter, if you feed it a stereo signal, the resulting output will also be in stereo.



The Low Pass Filter

Let's have a look at the controls that are at your disposal:

- Input drive
- Cut-off frequency
- Emphasis
- Dry/Wet
- Output volume

6.1. Drive

Here's a knob with history! Early on users of the Ladder Filter discovered that they could drastically change the sound of the filter by feeding the output of the filter back into itself. It's a way of overloading the filter circuit that causes a (usually) pleasant form of harmonic distortion. Filters it turns out, are very sensitive to the amplitude level of the sound you feed them; the Drive knob allows you to carefully adjust the input level.



Drive: a uni-polar dial

The drive and output level dials enable you to control the gain structure of the filter. This is important if you want to achieve the best possible signal-to-noise ratio. The preferred way to use the filter is to first set the gain structure with the drive and output volume dials before starting to work with the Cutoff Frequency and Emphasis dials. Changing the Drive level will also affect the sensitivity of the Envelope Follower.

6.2. Cut-off frequency

The Frequency dial enables you to control the filter cut-off point manually. It can of course also be brought under MIDI control by assigning a dial or a slider on your controller. If it does not stop there, you can control it with any source of control available on your DAW.

In its fully anticlockwise position, the frequency cut-off point is approximately 30Hz. As you rotate the knob clockwise frequency cut-off point will increase until, in its fully clockwise position, it exceeds 15kHz. These extreme positions are called 'closed' and 'open' respectively.

6.3. Emphasis or Q

A second setting to complement the cut-off frequency: Emphasis. Sometimes called "Resonance" or "Q" - for Quality of filtering.

Emphasis amplifies frequencies close to the cut-off frequency. The remaining frequencies are either unchanged (below the cut-off frequency) or reduced (above the cut-off frequency).

The Emphasis dial increases the amount of resonance; the filter becomes more selective, the cut-off frequency is amplified, and the sound begins to "ring" and will severely color any signal passing through it. By default the filter will never go into self-oscillation.

The example below illustrates how the Mini-Filter can be used as an oscillator. To make it a bit more special we'll also demonstrate how to control oscillator pitch with two control sources simultaneously; the LFO and the Sequencer. We'll start with all knobs in the Mini-Filter in their default position. To be certain this is the case please load the init preset.

Another thing that needs to happen is to load a clip in the track of the DAW and press "play" to activate the filter.

When you open the Mini-Filter plugin in your DAW the filter is in limited-resonance mode. Turning the emphasis dial fully clockwise does not make the filter self-oscillate. If you want to use the filter as an oscillator you'll have to disable this limitation by clicking on the "Limit Resonance" menu item in the lower right corner.

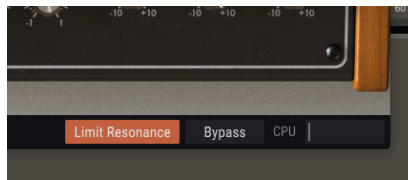

enabling self-oscillation

- now turn the emphasis knob fully clockwise. The filter is now self-oscillating: it has become an oscillator with a very pure sine wave
- set the filter frequency to about -2. This tunes down the oscillator frequency to a range suitable for our purpose.
- disable sync for the LFO and for the Step Sequencer. We want to have full manual control over both LFO and Sequencer
- set cut-off modulation on the step sequencer panel to +4. Nothing will happen yet. To hear the effect of the sequencer on our "Oscillator" we have to
- activate the sequencer steps by tuning them to + or - positions. Turn the individual steps clockwise or anti clockwise to create a melodic sequence. You should now hear the effect of the sequencer on the cut-off frequency of the oscillator.

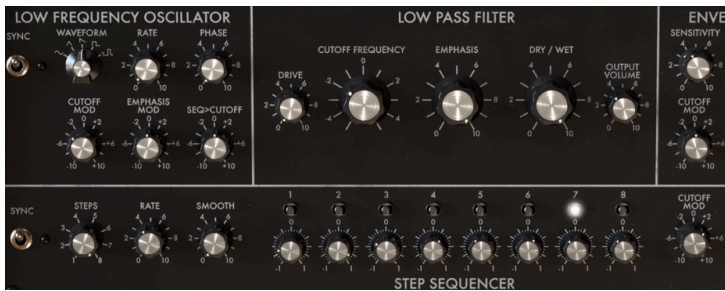

filter as oscillator

We'll add a second source of control by adding the LFO. By default the LFO's falling saw tooth is selected, which is perfect for our demonstration.

- Set the rate of the LFO to 0.5
- Set the cut-off mod dial in the LFO section to -3. The LFO modulation will now be added to the Sequencer modulation of the cut-off frequency. The effect of this combined modulation is that the original sequence is transposed by the LFO modulation. The pitches of the sequence will slowly rise and then fall as the LFO starts a new cycle.

You may ask yourself why the sequencer pitches rise when modulated by a falling sawtooth? The answer to this is simple: we've dialed a negative modulation amount into the LFO cut-off knob. This effectively turns the falling sawtooth into a rising sawtooth.

6.4. Dry/wet

This dial enables you to balance original (source) signal and processed signal. Set to zero you will only hear the original signal, set to maximum the signal will be 100% wet.

6.5. Output Volume

The Output volume will help you to balance the level of the Mini-Filter in the mix. Filtering will often reduce the level of the processed signal. Here's where you can compensate for this effect.

7. ENVELOPE FOLLOWER

In the early days of electronic music, it had a reputation for being sterile. In fact, it often was. The only way to shape the loudness of the sound was using an envelope generator. Composers and performers started looking for alternative ways to create interesting amplitudes.



Envelope Follower overview

The envelope follower was the answer to their prayers. An envelope follower registers the loudness/amplitude of an incoming signal and creates a control voltage contour that is an exact match of that signal. When you use that voltage contour to control the cut-off frequency of a filter you have a way to control the Cutoff frequency that is much more varied than is possible with an LFO. If your input signal is a repeating drum sound, the filter will follow along. It's because of this that you'll often hear an Envelope Follower referred to as "auto wah".

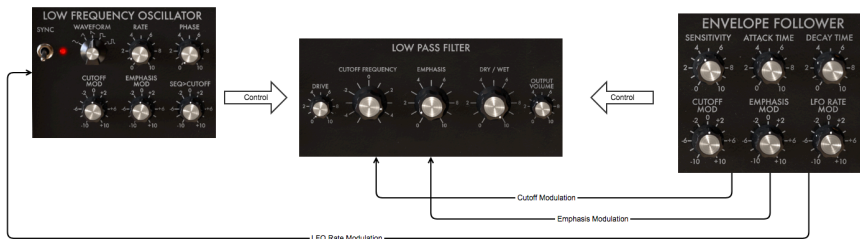

Envelope Follower signal flow: EF in closeup

Whereas an LFO will sweep a filter frequency gradually, an Envelope Follower can modulate the cut-off frequency rhythmically.

If you want to try this with the Mini-Filter:

- copy an instance of the Mini-Filter to an audio track on your DAW and load a clip that you want to filter
- press start on your DAW, you should now hear the clip playing
- set cut-off modulation on the EF to about -3
- set sensitivity to about 6
- set the cut-off frequency of the filter to -2
- set emphasis to about 7, you should now hear the ringing of the filter. By increasing the emphasis amount you have narrowed the filter band to such extent that the filter almost starts to self-oscillate.
- Now set the cut-off modulation in the LFO section to +3

You should now hear the filter respond rhythmically to the amplitude of the incoming sound. It dynamically selects a narrow harmonic band from the source in your clip. If you want to experiment further increase the drive amount.

The Envelope Follower of the Mini-Filter will track the amplitude of the incoming signal, translate it to a control signal and use that signal to modulate the cut-off frequency of the Low Pass Filter. The amount and the speed of the envelope response can be adjusted.

7.1. Sensitivity

The sensitivity dial determines the amount of detail with which the Envelope Follower will mimic the contour of the incoming signal. Cranking up the dial will amplify the level of incoming signal. A low sensitivity level will result in an approximation of the incoming signal, a high sensitivity setting in a detailed amplitude copy of the input signal.



*The
sensitivity
dial*



Remember how we discussed the use of the 'drive' knob to introduce harmonic distortion? When adjusting the Sensitivity on the envelope follower it is a good idea to do this in tandem with the drive dial; finding the right balance between drive and sensitivity can help you to maximize the effect of your filter.

7.2. Attack and Decay Time

The Attack Time dial controls the speed with which the Envelope Follower reacts to a rise in signal amplitude. When set to maximum it will respond immediately. When set to minimum the response will be dampened. In other words; it controls the slew rate of the response.



Attack and decay time uni-polar dials

The Decay Time dial has a similar function, but the Decay reacts to decreases in signal amplitude: when set to maximum it will respond immediately; when set to minimum it will be slower to respond. It controls the slew rate of a falling signal. Carefully adjusting these response settings is crucial in mastering the Mini-Filter.

7.3. Cutoff, Emphasis and LFO rate Mod

The Cutoff MOD dial determines to what extent the filter cut-off frequency is affected by the signal input level. Positive values increase the filter cut-off as the input amplitude increases; the filter opens as the signal gets louder. Negative values in the zero to -10 range decrease the filter cut-off as input amplitude increases; the filter closes as the signal gets louder.



Modulation options



Double Click a knob to return it to its default value.

The Emphasis MOD dial determines how much the filter emphasis is affected by the signal input level. Positive values increase the emphasis amount as the input amplitude increases; filter emphasis (Q) increases as the signal gets louder. Negative values in the zero to -10 range decrease the emphasis amount as input amplitude increases.

The LFO MOD dial will link the LFO rate to the amplitude of the incoming signal. Positive values in the range zero to +10 increase the LFO rate as the input amplitude increases. Negative values in the zero to -10 range decrease the LFO rate.



Remember that all dials of the Mini-Filter can be brought under MIDI control in the MIDI assign menu.

8. STEP SEQUENCER

A Sequencer is a versatile tool that enables you to create a myriad of modulation patterns. The Mini-Filter sequencer is an 8 step sequencer that you can use to modulate Filter Cut-off Frequency, Filter Emphasis and LFO Rate.

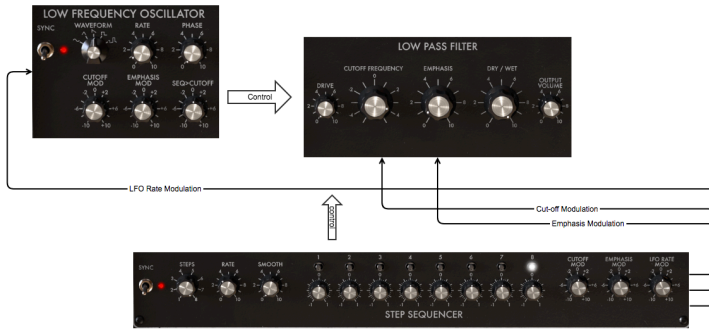

The sequencer as a modulation source

By default all 8 steps are active. You can change the length with the Steps dial. The steps are modulation dials and as such bipolar. They allow you to increase or decrease the value of the modulation target.



Step sequencer overview

The little blinking "LEDs" above each step will show whether a step is active or passive. They are a great help when "programming" the steps to modulate a target. On startup, the steps will have a default value of zero. In that position, they will not have any effect.



Note: to reset a dial to zero double click on it.

8.1. The Step Controls

The three knobs on the left allow you to control the behavior of the Sequencer.



The sequencer controls

8.1.1. Sequencer Sync

The Sync option is the key to unlocking the creative power of the sequencer. By default, sync is on.

When Sync is active your sequencer's tempo is locked to main the clock of your DAW. With each trigger it receives from the tempo clock of your DAW the sequencer will advance one step. The Sync as implemented in the Mini-Filter is intelligent. It does not just blindly follow the DAW clock but can lock it in different tempos.



The Sync dial

When you crank up the rate dial, Sync will try to lock to the nearest multiple of the tempo of your DAW. If your DAW is running at 120 BPM you can make the Mini-Filter run at 60 BPM, 90 BPM, or 240 BPM by turning the Rate dial. When turning the Rate dial its current value will be displayed in the toolbar.

By default sync is active and the Sequencer Sync Rate is set to 1/4. In this position one sequencer step equals 1/4th of a four beat measure; the sequencer will advance one step with every beat. If you double the rate to 1/8 the sequencer will run twice as fast as the DAW clock. Intermediate rate and smooth values will generate all sorts of interesting rhythmic effects.

When Sync is off, the length of a step can be varied from 0.1s-10s. By default, the length is 1 second.

8.2. Steps

Each step can modulate its target positively or negatively. When positive the modulation amount will be added to the value of the target, when negative the modulation amount will be subtracted from it. By default, the value of a step is zero. A reminder: you can restore this setting by clicking twice on a step.



The eight sequencer steps

You set length of a sequence with the Step dial. The default length is 8.

8.2.1. Rate and Smooth dials

The sequencer rate dial works in a similar way as the LFO rate dial. By default, the Sequencer will be synced to the clock of your DAW and will follow any changes in your DAW's clock proportionally. In the default setting Sequencer will sync to the clock of your DAW in a one-to-one relationship. Turning up the rate dial will change that relationship proportionally: the Sequencer rate will be quantized and cycle through a number of proportions 1:0, 0.5, 1:1, 1:2, 1:4, 1:8, etc.



Rate and Smooth dials

If needed you can uncouple the Sequencer from the DAW's tempo by disabling sync. The Sequencer rate will now be independent of the DAW clock.

8.3. Smooth

The smooth knob will soften the transition between the modulation of one step and the next. The clearest way to hear this is to set the number of steps to two as in the start of this example. When set to zero the transition from one step to another is very abrupt. When you increase the value of the smooth dial the transition will become more gradual.

8.4. The Modulation Controls

The values you dial in with these knobs will define the amount of modulation the sequencer will apply to the filter; either to the cut-off frequency or to the filter emphasis.



8.5. Cut-off Mod

This control targets the the main cut-off frequency of the Mini-Filter. As illustrated in the introduction it is a very useful tool to highlight beats in bar, or to emphasize instruments in certain frequency ranges. It's a bipolar dial; positive values will be added to the current setting of the cut-off frequency, negative values will be subtracted from it.

8.6. Emphasis Mod

Emphasis modulation targets the width of the Filter's resonance or Q band. When you narrow the resonance band you will emphasize certain harmonics or a harmonic range. This can be a great tool to bring certain instruments or sounds to the front in a mix. Or if the situation requires it, to dampen instruments in a specific frequency range. All this can be done in a dynamic way that is not possible with a fixed filter.

8.7. LFO Rate Mod

Especially when synced to your DAW clock this option can be used to great effect. For example by running the sequencer at a very slow rate and having it step at the start of each measure. By "programming" specific values in each step, the speed of the LFO will change at the start of each new measure. When using all eight steps you can increase or decrease the LFO rate in an eight bar loop.

9. SOFTWARE LICENSE AGREEMENT

In consideration of payment of the Licensee fee, which is a portion of the price you paid, Arturia, as Licensor, grants to you (hereinafter termed "Licensee") a nonexclusive right to use this copy of the SOFTWARE.

All intellectual property rights in the software belong to Arturia SA (hereinafter: "Arturia"). Arturia permits you only to copy, download, install and use the software in accordance with the terms and conditions of this Agreement.

The product contains product activation for protection against unlawful copying. The OEM software can be used only following registration.

Internet access is required for the activation process. The terms and conditions for use of the software by you, the end-user, appear below. By installing the software on your computer you agree to these terms and conditions. Please read the following text carefully in its entirety. If you do not approve these terms and conditions, you must not install this software. In this event give the product back to where you have purchased it (including all written material, the complete undamaged packing as well as the enclosed hardware) immediately but at the latest within 30 days in return for a refund of the purchase price.

1. Software Ownership

Arturia shall retain full and complete title to the SOFTWARE recorded on the enclosed disks and all subsequent copies of the SOFTWARE, regardless of the media or form on or in which the original disks or copies may exist. The License is not a sale of the original SOFTWARE.

2. Grant of License

Arturia grants you a non-exclusive license for the use of the software according to the terms and conditions of this Agreement. You may not lease, loan or sub-license the software.

The use of the software within a network is illegal where there is the possibility of a contemporaneous multiple use of the program.

You are entitled to prepare a backup copy of the software which will not be used for purposes other than storage purposes.

You shall have no further right or interest to use the software other than the limited rights as specified in this Agreement. Arturia reserves all rights not expressly granted.

3. Activation of the Software

Arturia may use a compulsory activation of the software and a compulsory registration of the OEM software for license control to protect the software against unlawful copying. If you do not accept the terms and conditions of this Agreement, the software will not work.

In such a case the product including the software may only be returned within 30 days following acquisition of the product. Upon return a claim according to § 11 shall not apply.

4. Support, Upgrades and Updates after Product Registration

You can only receive support, upgrades and updates following the personal product registration. Support is provided only for the current version and for the previous version during one year after publication of the new version. Arturia can modify and partly or completely adjust the nature of the support (hotline, forum on the website etc.), upgrades and updates at any time.

The product registration is possible during the activation process or at any time later through the Internet. In such a process you are asked to agree to the storage and use of your personal data (name, address, contact, email-address, and license data) for the purposes specified above. Arturia may also forward these data to engaged third parties, in particular distributors, for support purposes and for the verification of the upgrade or update right.

5. No Unbundling

The software usually contains a variety of different files which in its configuration ensure the complete functionality of the software. The software may be used as one product only. It is not required that you use or install all components of the software. You must not arrange components of the software in a new way and develop a modified version of the software or a new product as a result. The configuration of the software may not be modified for the purpose of distribution, assignment or resale.

6. Assignment of Rights

You may assign all your rights to use the software to another person subject to the conditions that (a) you assign to this other person (i) this Agreement and (ii) the software or hardware provided with the software, packed or preinstalled thereon, including all copies, upgrades, updates, backup copies and previous versions, which granted a right to an update or upgrade on this software, (b) you do not retain upgrades, updates, backup copies and previous versions of this software and (c) the recipient accepts the terms and conditions of this Agreement as well as other regulations pursuant to which you acquired a valid software license.

A return of the product due to a failure to accept the terms and conditions of this Agreement, e.g. the product activation, shall not be possible following the assignment of rights.

7. Upgrades and Updates

You must have a valid license for the previous or more inferior version of the software in order to be allowed to use an upgrade or update for the software. Upon transferring this previous or more inferior version of the software to third parties the right to use the upgrade or update of the software shall expire.

The acquisition of an upgrade or update does not in itself confer any right to use the software.

The right of support for the previous or inferior version of the software expires upon the installation of an upgrade or update.

8. Limited Warranty

Arturia warrants that the disks on which the software is furnished is free from defects in materials and workmanship under normal use for a period of thirty (30) days from the date of purchase. Your receipt shall be evidence of the date of purchase. Any implied warranties on the software are limited to thirty (30) days from the date of purchase. Some states do not allow limitations on duration of an implied warranty, so the above limitation may not apply to you. All programs and accompanying materials are provided "as is" without warranty of any kind. The complete risk as to the quality and performance of the programs is with you. Should the program prove defective, you assume the entire cost of all necessary servicing, repair or correction.

9. Remedies

Arturia's entire liability and your exclusive remedy shall be at Arturia's option either (a) return of the purchase price or (b) replacement of the disk that does not meet the Limited Warranty and which is returned to Arturia with a copy of your receipt. This limited Warranty is void if failure of the software has resulted from accident, abuse, modification, or misapplication. Any replacement software will be warranted for the remainder of the original warranty period or thirty (30) days, whichever is longer.

10. No other Warranties

The above warranties are in lieu of all other warranties, expressed or implied, including but not limited to, the implied warranties of merchantability and fitness for a particular purpose. No oral or written information or advice given by Arturia, its dealers, distributors, agents or employees shall create a warranty or in any way increase the scope of this limited warranty.

11. No Liability for Consequential Damages

Neither Arturia nor anyone else involved in the creation, production, or delivery of this product shall be liable for any direct, indirect, consequential, or incidental damages arising out of the use of, or inability to use this product (including without limitation, damages for loss of business profits, business interruption, loss of business information and the like) even if Arturia was previously advised of the possibility of such damages. Some states do not allow limitations on the length of an implied warranty or the exclusion or limitation of incidental or consequential damages, so the above limitation or exclusions may not apply to you. This warranty gives you specific legal rights, and you may also have other rights which vary from state to state.